

0 603 385 703

Stand }  
Issue } 06-07-24

**Fig./Abb. 2**

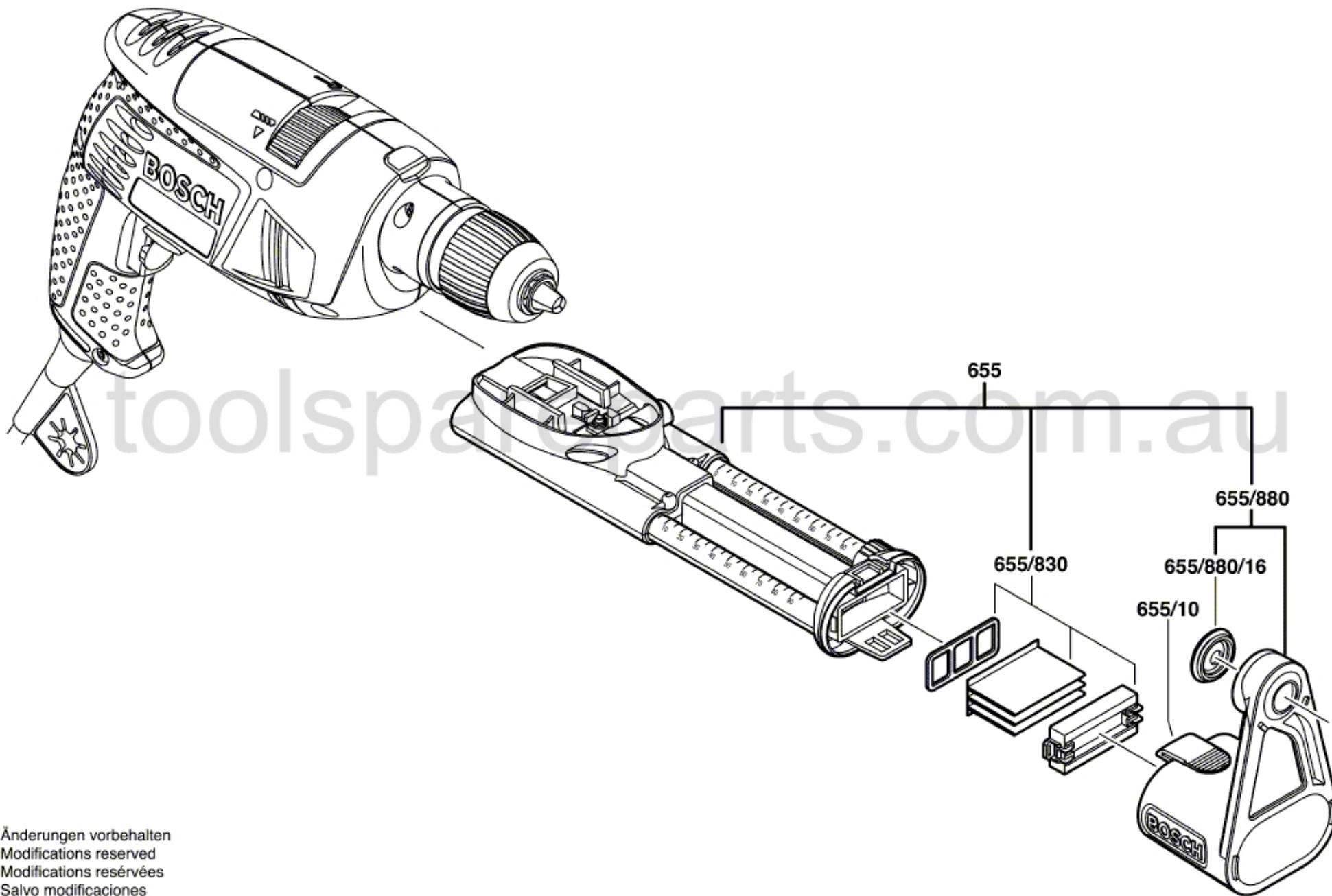

Änderungen vorbehalten  
Modifications reserved  
Modifications réservées  
Salvo modificaciones